

6

5

4

3

2

1

D

D

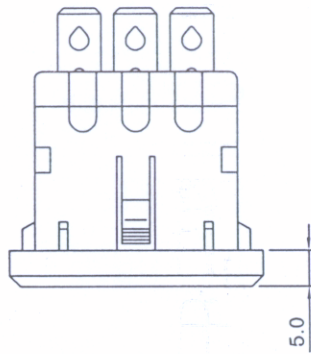

C

C

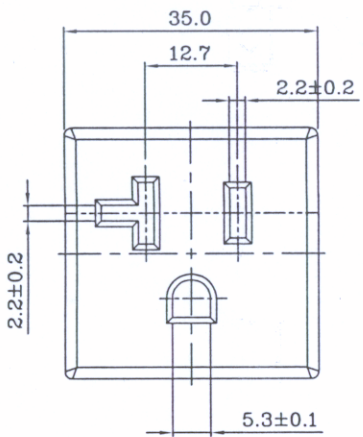

B

B

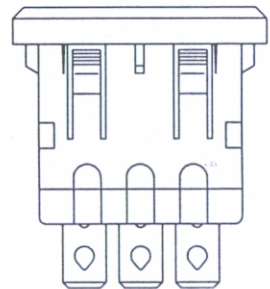

A

A

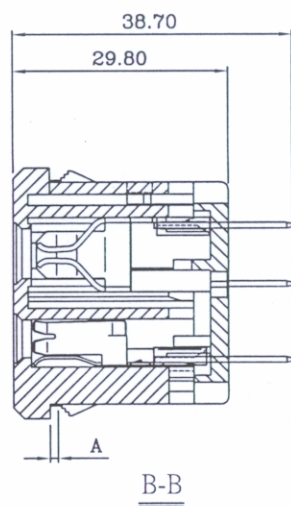

B-B

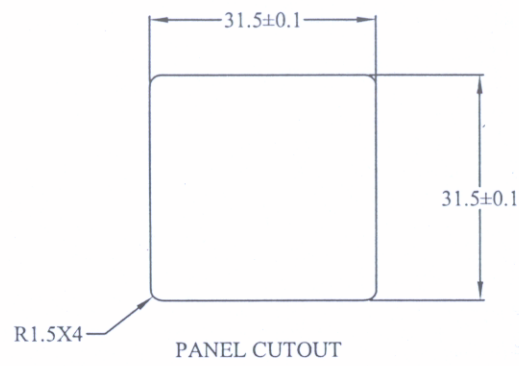
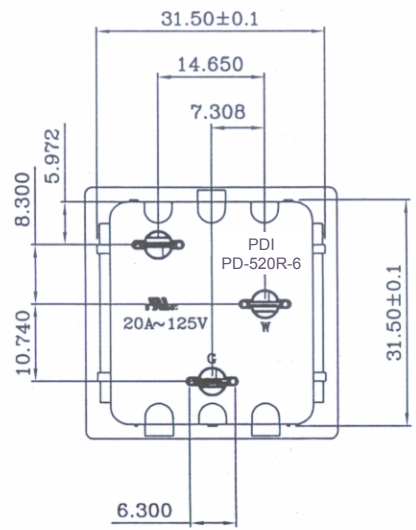

PANEL CUTOUT

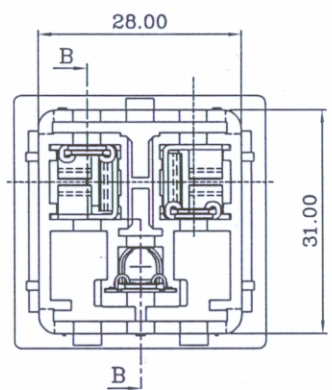

MATERIAL:
 Housing & Back Cover: Nylon, UL-94V-0 color black
 Contacts: Copper alloy

ELECTRICAL SPECIFICATIONS:
 Rated current & voltage: 20A 125VAC

APPROVALS:  US

RoHS COMPLIANT

REVISIONS	CHNG	CHK	APPR
	DATE		
REV	DATE		

TOLERANCE UNLESS OTHERWISE SPECIFIED	
X	± 1
X.X	± 0.4
X.XX	± 0.20

Power Dynamics, Inc.

Phone: 973 560-0019 Whippany, New Jersey Fax: 973 560-0076

PART: NEMA 5-15R / 5-20R; 6.4 Q.C. TAB
 SNAP IN PANEL MOUNT RECEPTACLE

DRAWN BY: PB	DATE: 4/14/09
CHECK BY:	DATE:
APPR BY:	DATE:

PART #: PD-520R-6		SHEET 1 of 1
SIZE: A	ALL DIMENSIONS FOR REFERENCE ONLY DIMENSIONS ARE IN MILLIMETERS	
SCALE: NTS		REV:

6

5

4

3

2

1